

**Inhalt**  
**Contents**  
**Contenu**

**Inhoud**  
**Contenido**  
**Conteúdo**

**Contenuto**  
**Содержание**  
**目录**

Einzelteilübersicht / Spare parts list / Liste des pièces détachées / Onderdelenoverzicht / Lista da piezas / Resumo de peça individual /  
Singoli componenti / Перечень деталей / 零件概览 ..... 2

Montagetips / Tips for assembly / Tuyaux pour le montage / Montagetips / Consejos para el montaje / "Dicas" para montagem /  
Consigli per il montaggio / Советы по сборке / 装配建议 ..... 3

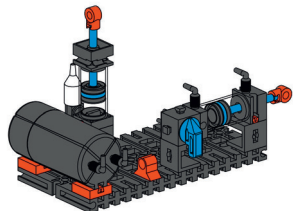

Funktionsmodell / Function model / Maquette fonctionnelle / Functiemodel /  
Modelo funcional / Modelo funcional / Modello di funzionamento /  
Действующая модель / 功能模型 ..... 4

Werkstattkran / Workshop crane / Grue d'atelier / Werkplaatskraan /  
Grúa de taller / Guincho para oficina / Gru da oficina / Цеховой кран /  
车间吊机 ..... 6

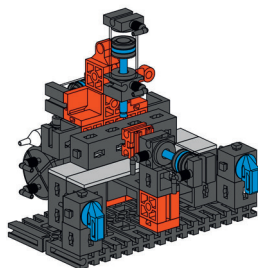
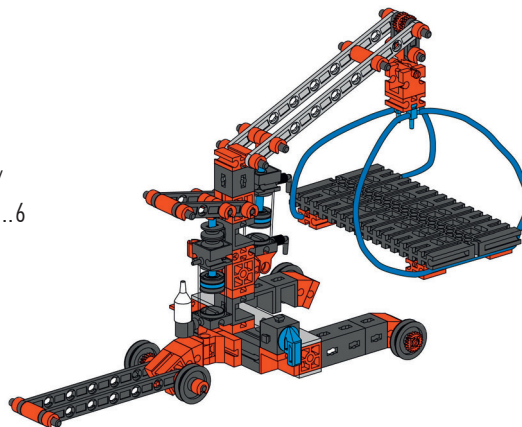





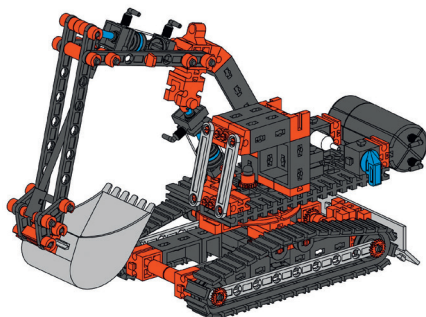
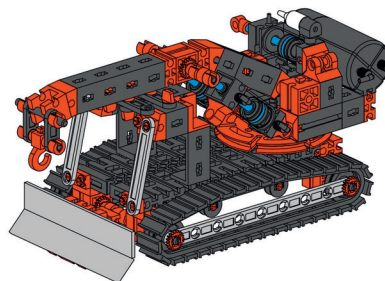









Stanzmaschine / Punch press / Découpeuse / Stansmachine /  
Punzonadora / Máquina de puncionar / Fustellatrice /  
Штамповочная машина / 冲床 ..... 11

Bergungsraupe / Track mounted recovery vehicle / Chenille de sauvetage /  
Bergingsvoertuig op rupsbanden / Oruga de salvamento / Lagarta de  
salvamento / Cingolato di salvataggio / Спасательный трактор /  
履带式抢险车 ..... 14





Bagger / Excavator / Pelle / Graafmachine / Excavadora / Escavadeira /  
Escavatore / Экскаватор / 挖掘机 ..... 19

**Einzelteilübersicht**  
**Spare parts list**  
**Liste des pièces détachées**

	31 011 2 x
	31 019 1 x
	31 057 2 x
	31 058 1 x
	31 422 3 x
	31 426 3 x
	31 436 3 x
	31 597 14 x
	31 642 2 x
	31 690 1 x
	31 981 3 x
	31 982 11 x
	31 983 3 x
	32 064 7 x

**Onderdelenoverzicht**  
**Lista da piezas**  
**Resumo de peça individual**

	32 870 1 x
	32 879 2 x
	35 031 1 x
	35 066 1 x
	35 129 1 x
	35 414 2 x
	35 797 4 x
	35 969 2 x
	35 975 4 x
	35 980 1 x
	36 227 2 x
	36 323 6 x
	36 334 15 x
	36 586 4 x

	36 913 2 x
	36 914 4 x
	36 915 6 x
	36 920 8 x
	36 921 1 x
	36 922 6 x
	36 934 2 x
	36 970 1 x
	37 237 6 x
	37 468 7 x
	37 636 1 x
	37 679 27 x
	38 225 1 x
	38 240 2 x

**Singoli componenti**  
**Перечень деталей**  
**零件概览**

	38 258 4 x
	38 411 1 x
	38 413 3 x
	38 414 6 x
	38 416 1 x
	38 543 2 x
	38 546 2 x
	122 641 3 x
	153 367 2 x
	156 104 1 x
	156 105 2 x
	156 106 2 x
	156 107 1 x
	156 493 1 x